



TOPWORX™
D-ESD

TopWorx™ D-ESD SIL-3 Rated Valve Controllers

Automated “Partial Stroke Testing” of Emergency Shutdown Valves

- Suitable for use in SIL-3 applications
- Certified for use in all hazardous areas
- Integrated solution with all controls in a single housing
- Onboard diagnostics for performance validation



SAFETY INSTRUMENTED SYSTEMS (SIS)

Safety Instrumented Systems (SIS) are designed to protect employees, equipment, and the environment against the risks associated with the processing of toxic or flammable fluids.

A Safety Instrumented System consists of:

Logic Solver

PLC that compares process conditions to predetermined process limits

Sensors

Level, temperature, pressure, and flow sensors to monitor process conditions

Final Control Element

Valve, actuator, and solenoid assembly to shutdown the supply of toxic or flammable fluids in case of an emergency

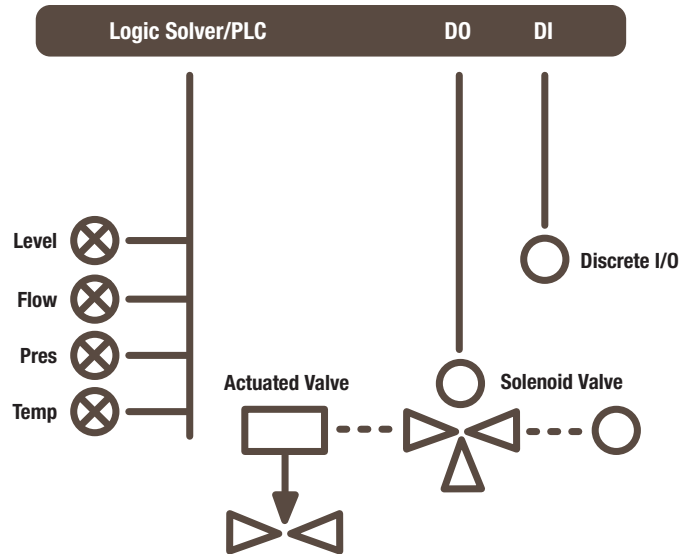

Determining SIL Values

The IEC 61508 standard sets guidelines for how to determine the need for a Safety Instrumented System and to determine the level of safety required. The IEC standard uses two inputs to calculate Safety Integrity Levels (SIL Ratings) for a process and system – Level of Risk and Probability of Failure on Demand per year (PFD).

The Safety Integrity Level (SIL) of the Safety Instrument System (SIS) is obtained by adding the PFD value of each of the components in the SIS and then comparing this value to the figures in Table 3 (next page).

Level of Risk

The first input into assigning a SIL Rating is to determine the Level of Risk for a process and therefore the corresponding need for a Safety Instrumented System. This risk is normally assessed during a Hazardous Operations Study.

SIL	Qualitative View of SIL
4	Possible Consequences Catastrophic Community Impact Potential for fatalities in the community
3	Employee and Community Impact Potential for multiple fatalities
2	Major Property and Production Protection. Possible Injury to employee Potential for major serious injuries or one fatality
1	Minor Property and Production Protection Potential for minor injuries

Table 1

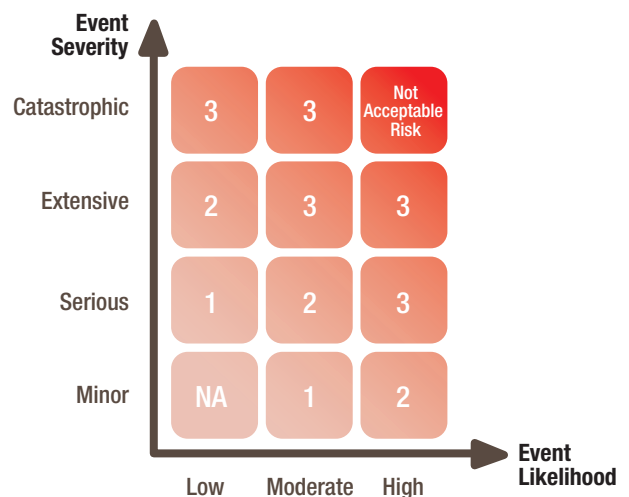

Table 2

Probability of Failure on Demand (PFD)

There are three recognized techniques for determining Probability of Failure on Demand for a SIS. They are Simplified Calculation, Fault Tree Analysis, and Markov Analysis. Simplified Calculation is both the least complex and the most conservative:

$$PFD_{avg} = (\text{Failure rate})^2 * \text{test interval}$$

$$\text{Failure Rate} = 1/\text{MTBF (Mean Time Between Failure)}$$

The Safety Integrity Level (SIL) of the Safety Instrumented System (SIS) is obtained by adding the PFD value of each of the components in the SIS and then comparing the value to the figures in Table 3.

$$PFD_{PLC} + PFD_{SENSOR} + PFD_{FCE}$$

For example, if the value is between 10^{-4} and 10^{-3} the SIS will have a SIL 3 rating.

(PLC = Plant Logic Controller, SENSOR, FCE = Final Control Element)

Should PFD data not be available for a component in the SIS, generic values can be obtained from various agencies based on collected field data. For example, generic data is available for components such as ball and butterfly valves, scotch-yoke and rack-n-pinion pneumatic actuators, and 3-way solenoid valves.

Safety Integrity Level	Probability of Failure on Demand	Risk Reduction Factor
SIL 4	$\geq 10^{-5}$ to $< 10^{-4}$	100,000 to 10,000
SIL 3	$\geq 10^{-4}$ to $< 10^{-3}$	10,000 to 1,000
SIL 2	$\geq 10^{-3}$ to $< 10^{-2}$	1,000 to 100
SIL 1	$\geq 10^{-2}$ to $< 10^{-1}$	100 to 10

Table 3

Analysis of Safety Instrumented System Failures

The majority of failures in a Safety Loop are caused by the Final Control Element (valve, actuator, and solenoid assembly).

These failures can be split into two categories – Safe Failures and Dangerous Failures. Dangerous Failures are component failures which will cause the Final Control Element not to perform as required in an emergency situation. Typical causes of Dangerous Failures include:

- Valve packing/shaft damage
- Actuator spring fatigue/breakage
- Solenoid pilot exhaust blockage
- Solenoid spring failure
- Poor air quality

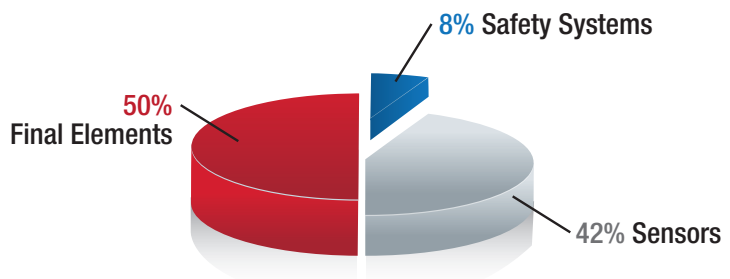

COMMON METHODS OF PARTIAL STROKE TESTING

Partial Stroke Testing (PST)

Since an Emergency Shutdown Valve is typically static in the full open position for long periods of time, it is necessary to test its functionality from time to time to prove its reliability and availability in accordance with its SIL rating.

In the past it was necessary to fully close the valve during testing, requiring the plant to undergo a costly shutdown or install an expensive bypass valve. Now, however, modern-day “Partial Stroke Test” devices promise to eliminate those costs while simultaneously improving safety.

During a Partial Stroke Test, an Emergency Shutdown Valve is partially closed just enough to prove the valve’s functionality but not interfere with the flow through the valve. Analysis of SIS failures has shown that performing a Partial Stroke Test regularly can dramatically extend the period of time between mandatory full stroke tests which shut down the process. This enables process plants to run continuously for a couple of years before a major shutdown is required and therefore often increases their profitability by millions of dollars.

Common Partial Stroke Test Methods

Mechanical Jamming

Limiting the valve movement mechanically with a stroke limiter in the actuator or on the valve

Limitations

- Emergency Shutdown Valve is NOT available during a partial stroke test!
- Larger sizes become proportionally more expensive to install
- No diagnostics or position feedback
- Labor intensive to perform a partial stroke test

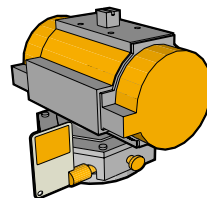

Mechanical Jammer in gearbox housing

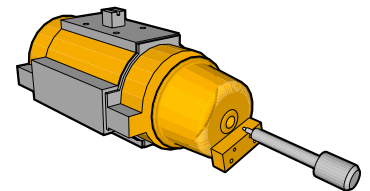

Mechanical Jammer in actuator endcap

Instrument Panel

Locally mounted control panel containing partial stroke test instrumentation

Limitations

- Expensive to design, build, and install
 - Always custom-designed, never an off-the-shelf standard design with standard components
 - Must buy multiple components from multiple vendors rather than a single solution from a single vendor
 - Labor intensive to perform a partial stroke test
 - Instrument Panel located on or near the valve
- Digital Positioner

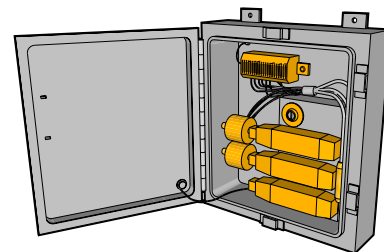

Instrument Panel located on or near the valve

Common Partial Stroke Test Methods (con't)

The TopWorx Solution

In effect, none of the conventional Partial Stroke Test devices that exist today deliver a high-value combination of functionality and price. Some have reasonable prices, but their functionality is too limited. Others have excellent functionality, but are too complex and excessively priced.

Fortunately, TopWorx has created **TopWorx™ D-ESD Valve Controllers** – a *low-cost, high-functionality* partial stroke testing solution. The D-ESD hits the “sweet spot” of the market by combining the advantages of common partial stroke test devices and leaving their disadvantages behind.

Functionality & Flexibility

The TopWorx D-ESD is so highly functional in part because it is also very flexible in its set-up. While many ESD/PST products limit the end-user to factory components only, the TopWorx D-ESD allows customers to use their preferred brand of solenoid valve. TopWorx solenoids are recommended, but many other site-preferred, “proven in use” solenoids may be integrated into the D-ESD while maintaining all of its best-in-class features. In fact, aside from the TopWorx 1.2 or 3.0Cv solenoids, the D-ESD may be fitted with a nipple-mounted solenoid that has a power consumption of 10 watts or less.

For example: in natural gas and hydraulic actuator applications, the D-ESD sensor communication module may be used in conjunction with a nipple/external solenoid to perform Partial Stroke Testing. Simply replace the failure rate values of the D-ESD integrated solenoid and pilot with that of the external solenoid to calculate the SIL rating for the final control element.

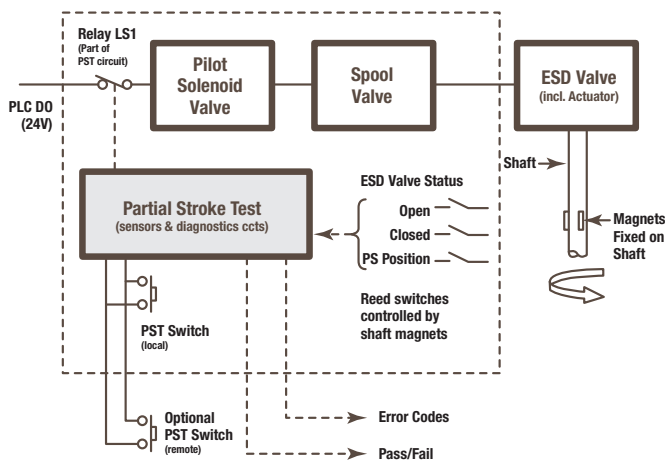

Notes: The PST (sensors & diagnostics ccts) shaded box is the subject of the FMEA in Appendix 1

PLC DO is the (fail safe) control signal:
 HI = ESD Valve Open
 LO = ESD Valve Closed

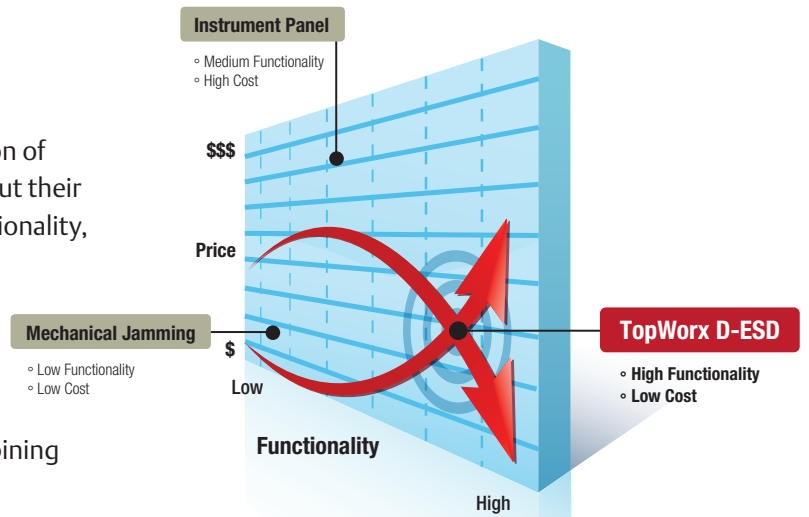

The external solenoid may replace the Pilot Solenoid Valve and Spool Valve for special applications.

FAILURE RATES

Sub Assembly	Symbol	Dangerous Undetected Failure Rate (per hr)	Dangerous Undetected Failure Rate w/PVST	Total Failure Rate (Including no effect) (per hr)	Total Failure Rate (excluding no effect) (per hr)
Valve	λ_{valve}	1.32E-07	7.44E-09	5.84E-07	2.25E-07
Pilot	λ_{pilot}	3.00E-09	3.00E-11	7.32E-08	5.27E-08
Solenoid	λ_{sol}	1.01E-07	3.71E-09	5.53E-07	2.60E-07
Relay	λ_{rel}	0.00E+00	0.00E+00	2.80E-08	2.80E-08
Total	λ_{total}	2.36E-07	1.12E-08	1.24E-06	5.66E-07

TOPWORX™ D-ESD SIL-3 PARTIAL STROKE TEST SOLUTIONS

TopWorx SIL-3 ESD Valve Controllers provide a complete Partial Stroke Test Solution with unique features and functionality that enable partial stroke testing of emergency shutdown valves without disrupting or shutting down the process.

The **TopWorx Partial Stroke Test Solution** comes complete with:

- Sensor Control Module to partially close the valve without disrupting the process
- Pass/Fail indication via high/low response on the return signal
- Open and Closed position sensors for feedback to the DCS or PLC
- Onboard Diagnostics to enable predictive maintenance and early-warning alerts
- Aluminum, Engineered Resin, and 316 Stainless Steel platforms certified for use in Flameproof/ Explosion Proof, or Non-Incendive hazardous areas
- An optional local, lockable partial stroke Test Button integral to the unit

The **TopWorx Partial Stroke Test Solution** provides Onboard Diagnostics to alert the user to the following Dangerous Failures:

- Valve packing/shaft damage
- Actuator spring fatigue/breakage
- Solenoid pilot exhaust blockage
- Solenoid spring failure



Convenient Partial Stroke Testing

Partial Stroke Test Module

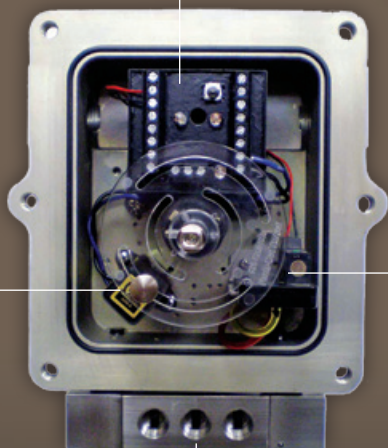

GO™ Switch
Partial Stroke Confirmation Switch

Integral Solenoid

Spool Valve

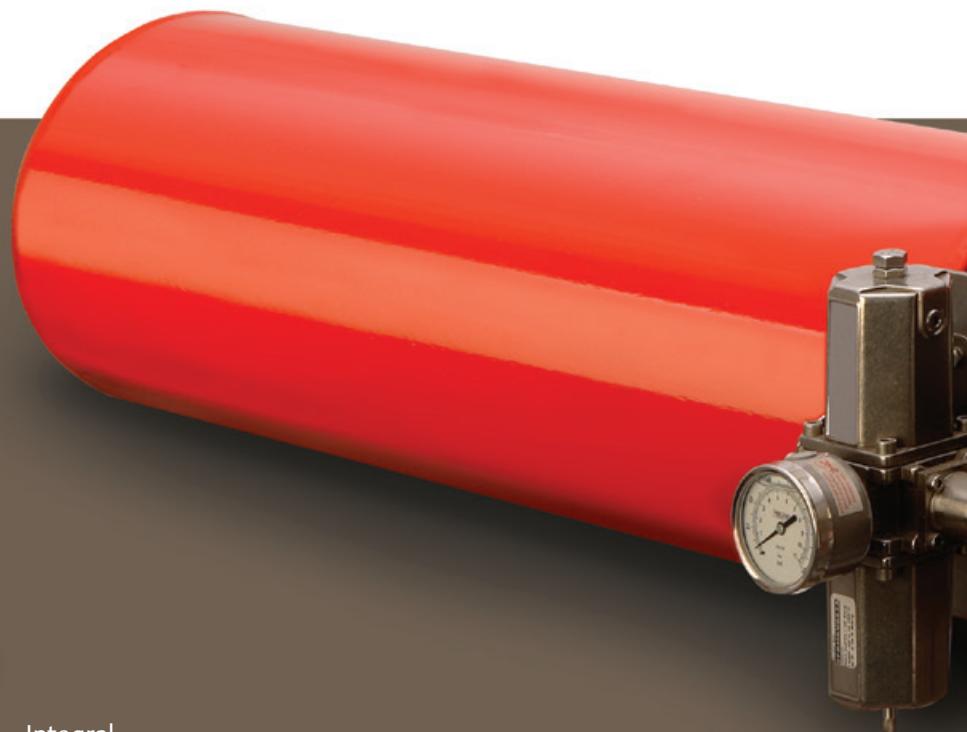

Available in three platforms suitable for your particular application:



DXP Tropicalized Aluminum
Flameproof/Explosion Proof



DXR Engineered Resin
Non-Incendive



DXS 316 Stainless Steel
Flameproof/Explosion Proof

SIL-3
IEC 61508

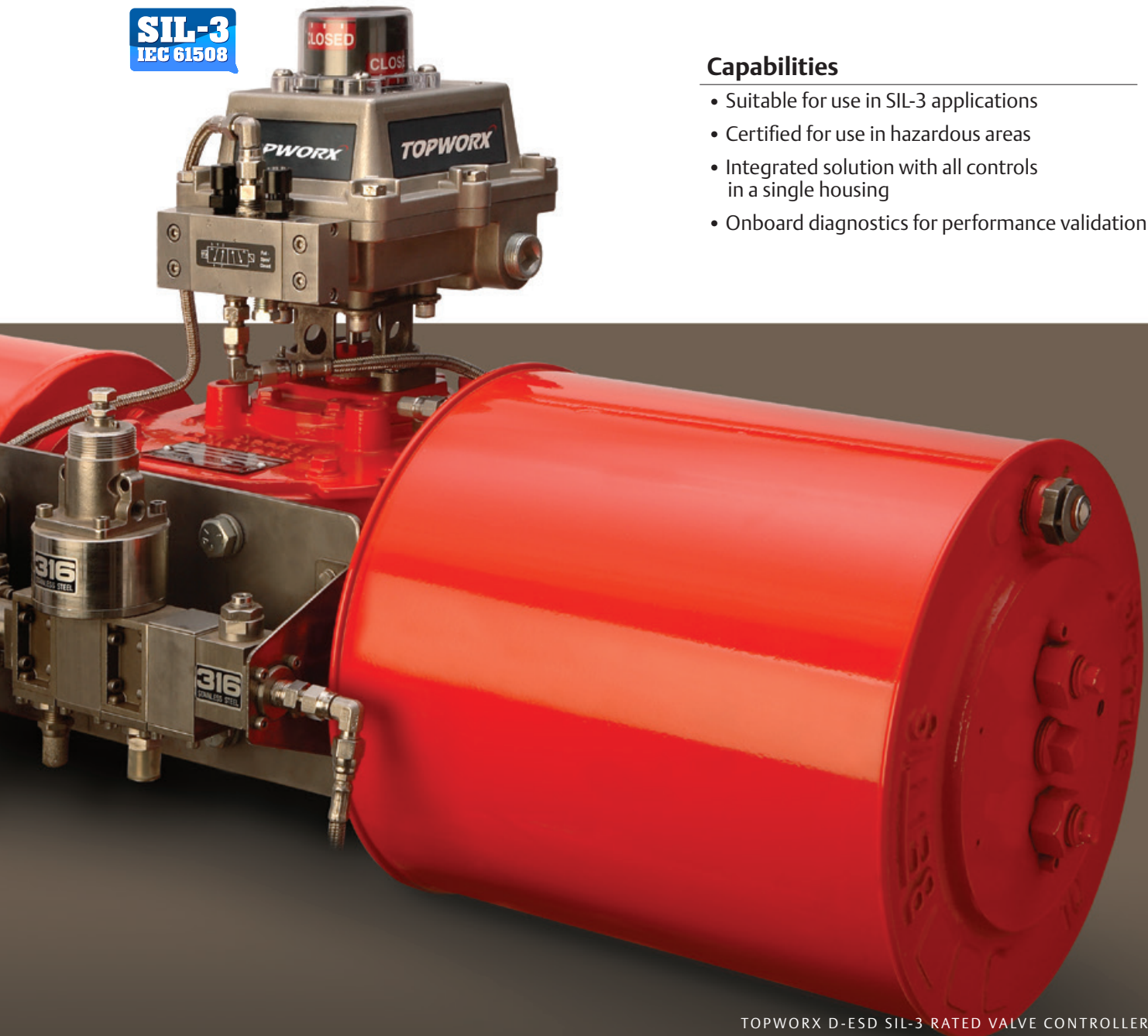

Capabilities

- Suitable for use in SIL-3 applications
- Certified for use in hazardous areas
- Integrated solution with all controls in a single housing
- Onboard diagnostics for performance validation

TOPWORX™ D-ESD TECHNICAL INFORMATION

Setup and Calibration

Once fitted to the valve and actuator and installed and powered up in the plant, the Partial Stroke Test position is set on the graduated cam to 10-20% from the fully open position. The unit is calibrated by pressing the push button provided on the Sensor Control Module and holding it for 5 seconds. During calibration a partial stroke test is automatically performed, recording the stroke time in the non-volatile memory. The unit is now completely calibrated.

Partial Stroke Testing

Partial Stroke Testing can now be performed in the field by pressing the external local Partial Stroke Test Button or by a pulsed DO from the PLC. In addition to partial stroke testing the unit is provided with open and closed position sensors as well as a pass/fail output for the PST function for feedback to the PLC or DCS.

This recorded time serves two functions:

1) Prevents accidental closing of the valve

If during testing the partial stroke test position is not reached within the time recorded during calibration (an adjustable safety factor is added to accommodate for changes due to external factors), the solenoid is re-energized, returning the valve to the open position and eliminating the risk of all the air being exhausted from the actuator.

2) Diagnostics

Should the partial stroke test fail as described above, an alert by means of an open circuit is shown on the feedback DI.

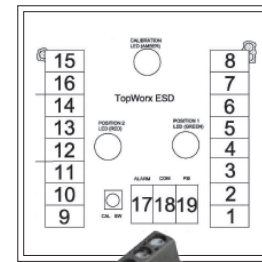
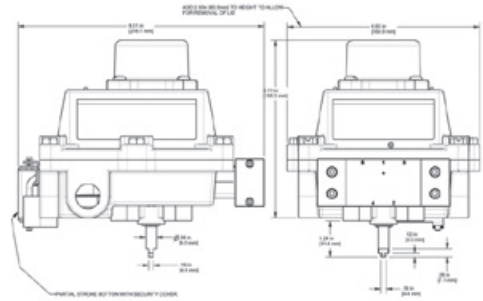

TopWorx™ D-ESD Integral Features and Functionality

Enclosure

- **All Controls are Integral and contained in a single, standard housing**
 - Limit switches, solenoid valve, test button, and diagnostics all in one device
 - Eliminates the process of designing and purchasing custom components from multiple vendors
- **Fewer Components = higher reliability and easier maintenance**
 - Uses standard valve controller platforms and components which have been field-proven in thousands of installations
- **Rugged Aluminum, Engineered Resin, or Stainless Steel platforms certified for all hazardous areas**
 - IECEx/ATEX Ex d, UL/cUL Class I Division 1 & 2
 - Conventional wiring solution enables Partial Stroke Testing on existing valves without the need for expensive controller upgrade
- **Local, lockable Partial Stroke Test Button is integral to the device and fully protected**
 - Eliminates external wiring and prevents tampering or accidental partial stroke test

Sensors and Diagnostics

- **Simple Pass/Fail Diagnostics**
 - No need for complex training or user interpretation
 - Regardless of how a failure is identified via valve signatures transmitted to an asset management system via HART or a simple Discrete Input to an existing DCS or PLC, the result is the same: Scheduled maintenance of the Final Control Element (FCE) must be performed to ensure the Safety Integrity Level of Safety Instrumented System
- **ESD Function overrides the Partial Stroke Test in the event of an emergency**
 - In an emergency, the partial stroke test will abort and the valve will fail closed
 - Peace of mind in knowing the valve will close (shutdown), even during a test
- **Anti-Slam Closed feature prevents a valve from accidentally closing during a test**
 - Eliminates the risk of spurious trips during a partial stroke test
- **Open and Closed position feedback to the control system**
 - Partial Stroke Test uses unique GO™ Switch technology for maximum reliability
 - All position sensors are hermetically-sealed, potential-free
 - All electronics are completely potted, sealed, and protected from the environment

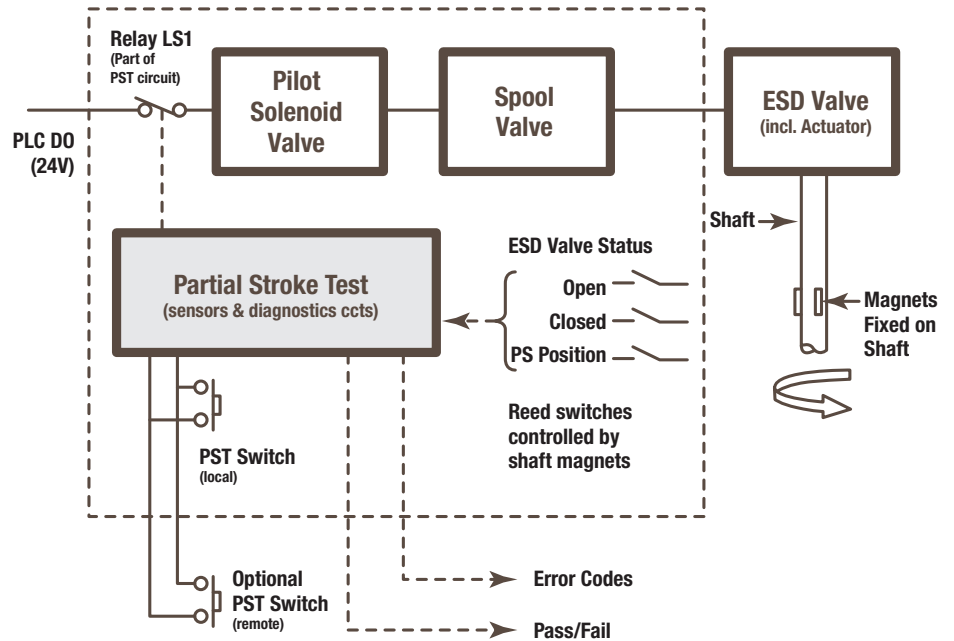

Notes: The PST (sensors & diagnostics ccts) shaded box is the subject of the FMEA in Appendix 1

PLC DO is the (fail safe) control signal:

Hi = ESD Valve Open

Lo = ESD Valve Closed

Solenoid Valve

- **Uses Standard Solenoid Valve Technology with flow rates of 1.2Cv, 3.0Cv**
 - NO additional boosters or quick exhaust with piping required
 - NO continuous air bleed (positioner-type devices use in excess of 1.3m³/hr)
- **Low Power Consumption (0.5 watts)**
 - Less heat generation in the coil ensures longer life when continuously energized, which is typical in an SIS
- **Built-in Flame Arrestors serve as 5-micron air filters**
 - Protects the pilot valve against poor quality air supply, preventing one of the leading causes of Dangerous Failures in an SIS
- **Full Air Pressure is transmitted by the pilot to the large cross-sectional area of the spool**
 - Ensures maximum force is transmitted to shift the solenoid spool when needed
- **Balanced Spool Design – all forces inside the spool are balanced**
 - Only air pressure from the pilot is needed to overcome seal stiction and spring force

Often mounted on rotary scotch-yoke actuators, TopWorx SIL-3 ESD Valve Controllers are also good for Linear Valve Applications.



TOPWORX™ D-ESD ORDERING INFORMATION

Ordering Guide

Enclosure	Area Classification	Visual Display	Shaft	Conduit	O-Rings	Pilot	Spool	Cv	Override
DXP-ES Tropicalized Aluminum	1 Explosion proof / Flame proof (DXP/S only) North America Class I Div 1&2 Groups C, D; Class I Div 2 Groups A, B, C, D. (Groups A & B must be hermetically sealed) Type 4, 4X, ATEX/IECEX Zone 1 II2G, II2GD Ex d IIB+H2 Ex tb IIIC Db, IP66/67 (O-Rings must be S or E for DUST certification) G General Purpose C Flameproof (DXP only; Conduit entries must be E or M) ATEX/IECEX II2G, II2GD Ex d IIC Ex tb IIIC Db, IP66/67 W No approvals Type 4, 4x IP 66/68	G Standard 90° Green, OPEN Red, CLOSED	S 1/4" DD 304 stainless N NAMUR 304 stainless	DXP/DXS (Metal Conduit Entries) E (2) 3/4" NPT 4 (2) 3/4" NPT (2) 1/2" NPT M (2) M20 3 (4) M20 6 (4) 3/4" NPT	B Buna-N S Silicone	1 (1) 24Vdc pilot, .5W, fail open/closed 7 (1) 110Vac pilot, 1.1W, fail open/closed	A Aluminum hard coat anodized S 304 stainless 6 316 stainless	2 1.2 Cv (1/4" NPT ports) 3 3.0 Cv (1/2" NPT ports)	T PST Button with lock cover
DXS-ES 316 Stainless Steel									
Ordering Guide Fill in the boxes to create your 'ordering number.'									
Enclosure	Area Classification	Visual Display	Shaft	Conduit	O-Rings	Pilot	Spool	Cv	Override

Suggested Specification

Emergency Shutdown Valve shall have Partial Stroke Test (PST) capability to periodically test the valve's functionality without shutting down or disrupting the process. PST solution shall stroke the valve automatically rather than manually, shall provide end of stroke position feedback, and shall provide a means to test the functionality of the solenoid valve. ESD valve must be available to perform at all times during a test.



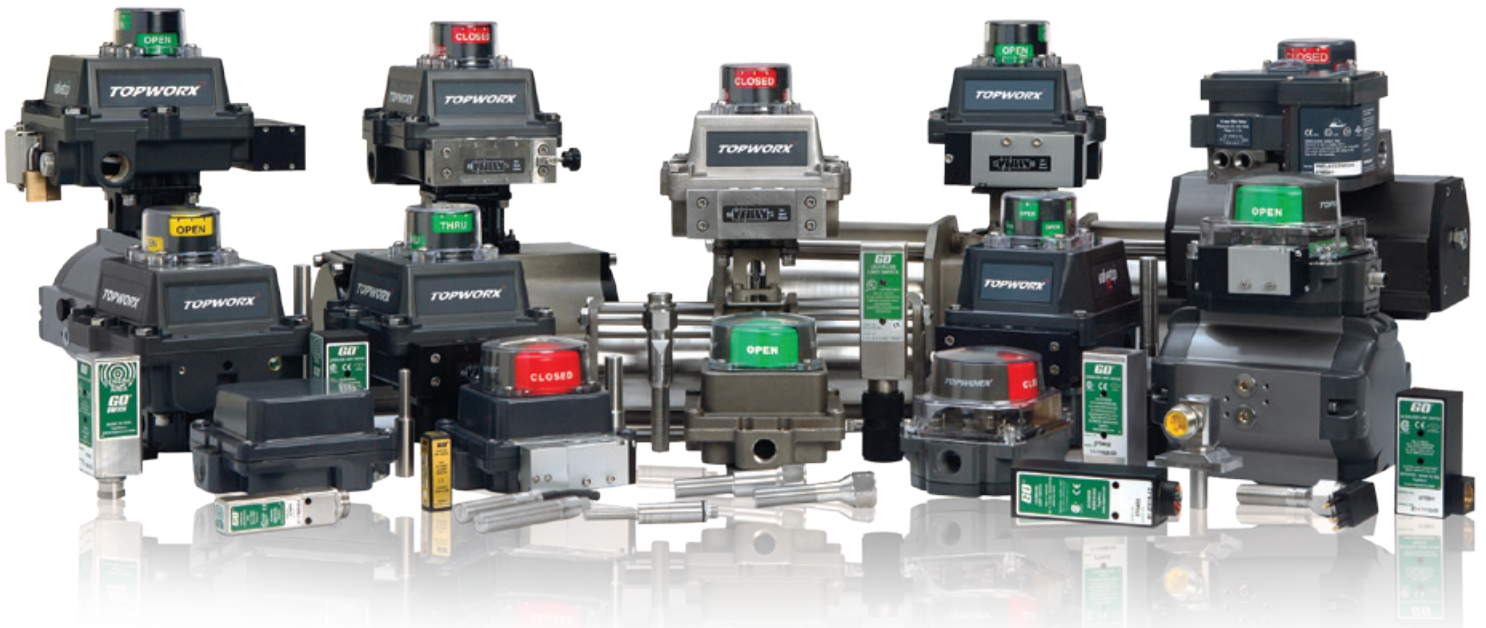

TopWorx™, a division of Emerson Process Management, is the global leader in valve control and position sensing for the process industries. Our solutions enable plants, platforms, and pipelines to manage and control operations more intelligently and efficiently under the most demanding and extreme conditions.

GLOBAL TECHNOLOGY LEADERSHIP

TopWorx™ technology advancements are at the forefront of innovation in the process automation industry. TopWorx™ uses wireless technologies and fieldbus protocols such as FOUNDATION Fieldbus, DeviceNet, AS-Interface, Profibus, and HART to reduce installation costs and enable predictive maintenance.

GLOBAL HAZARDOUS AREA CERTIFICATIONS

In addition to high temperature (204°C), cold temperature (-60°C), and sub-sea (6,800 meters) applications, TopWorx products are suitable for use in Flame-proof/Explosion Proof, Non-Incendive, Intrinsically Safe hazardous areas with IECEx, ATEX, GOST, InMetro, UL, KOSHA, and NEPSI certifications.

GLOBAL SERVICE & SUPPORT

With company locations in the United States, United Kingdom, South Africa, Bahrain, and Singapore, TopWorx™ is strategically positioned to provide outstanding support. In addition, over 200 Certified Product Partners throughout the world are available to provide competent local support when needed.



WWW.TOPWORX.COM

Visit www.topworx.com for comprehensive information on our company, capabilities, and products – including model numbers, data sheets, specifications, dimensions, and certifications.

GLOBAL SUPPORT OFFICES

Americas

3300 Fern Valley Road
Louisville, Kentucky 40213 USA
+1 502 969 8000
info.topworx@emerson.com

Asia-Pacific

1 Pandan Crescent
Singapore 128461
+65 6891 7550
info.topworx@emerson.com

Europe

Horsfield Way
Bredbury Industrial Estate
Stockport SK6 2SU
United Kingdom
+44 0 161 406 5155
info.topworx@emerson.com

Middle East

P.O. Box 17033
Jebel Ali Free Zone
Dubai 17033
United Arab Emirates
+971 4 811 8283
info.topworx@emerson.com

Africa

24 Angus Crescent
Longmeadow Business Estate East
Modderfontein
Gauteng
South Africa
+27 11 451 3700
info.topworx@emerson.com

Visit www.topworx.com for comprehensive information on our company, capabilities, and products – including model numbers, data sheets, specifications, dimensions, and certifications.

www.topworx.com

© 2016 TopWorx. All rights reserved. TopWorx, GO Switch, VIP and Leverless Limit Switch are all trademarks of TopWorx. The Emerson logo is a trademark and a service mark of Emerson Electric. Co. © 2016 Emerson Electric Company. All other marks are the property of their respective owners. Information herein – including product specifications – is subject to change without notice.

TOPWORX **GO**
SWITCH

About Emerson Process Management

Emerson Process Management is a powerful, global, single source of process improvement technology and expertise. We help major companies in selected industries optimize their plants and processes to achieve higher quality, greater reliability and faster time to market, while steadily advancing productivity and profitability. We can build it - providing experienced project management, engineering and a single point of accountability for the entire instrumentation and automation system. We can connect it -- seamlessly integrating people and technology at every level of the process. We can improve it -- creating more efficient utilization of energy and raw materials. And we can sustain it -- producing greater reliability, month after month, year after year. From the field, to the plant, to the bottom line -- where performance is the question, Emerson is the answer.

